

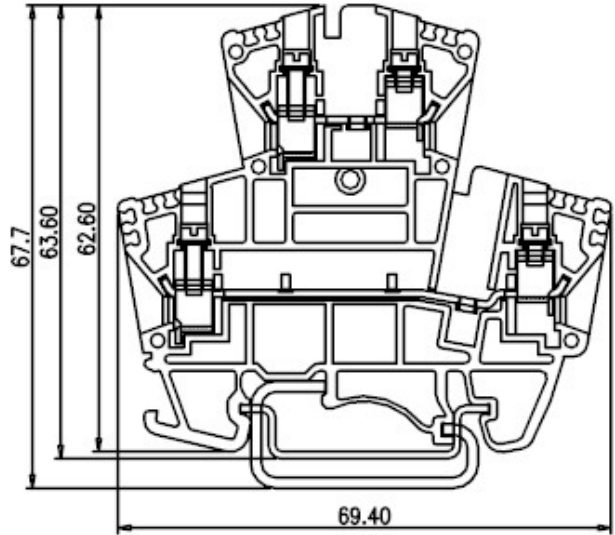



DIN Rail terminal blocks / DDK series



DDK2.5







TxHxW 5.1x62.85x69.4

Approval	  	
Technical Data	UL	IEC
Rated voltage	300V	400V
Rated current	20A	24A
Wire range		
Solid wire (AWG mm ²)	22~12	0.5~2.5
Stranded wire (AWG mm ²)	22~12	0.5~2.5
Rated surge voltage (UL/IEC/Max.)	1.6 / 2.5 / 6 KV	
Torque (Lb-in)	3.5	
Screw	M2.5	
Wire strip length	6mm	



Accessories	Cat. No.	
End cover	DDK2.5C	
Partition		
Small partition		
Cross jumper - central type	DS2.5	02P
		03P
		10P
Cross jumper - cage inserting type	CSC-2.5	02P
		03P
		10P
Suitable plugs		
Marking label	TM20	
Suitable rail	TS-35	
	TS-32	
Tool	SDM2.5	

Optional color	Cat. No.
	DDK2.5-RD
	DDK2.5-BL
	DDK2.5-BK
	DDK2.5-OR