

Barrier Style Terminal Blocks / DT-2G

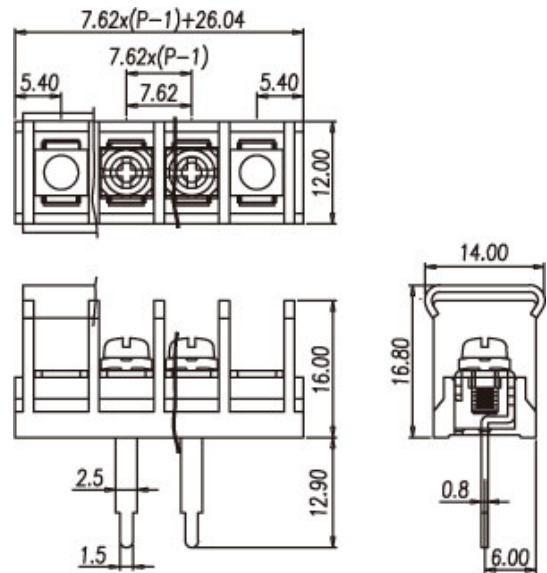

DT-2G-A04X-XX

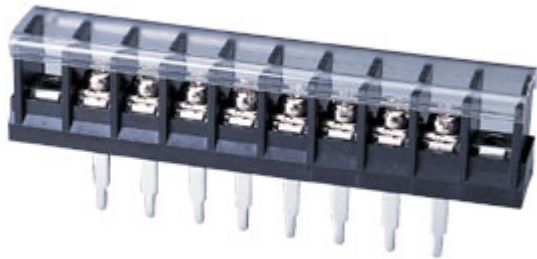

Pitch: 7.62mm

ORDER GUIDE

DT - 2 - **04** -

- Pole size: 02~26P
- N : Round head screw
- W : Screw with washer
- A : Mount Ends
- B : Barrier Ends
- G : With cover
- GN : Without cover

Approval



FW2

Materials

Rated voltage	300V
Rated current	15A
Plastic Housing	PBT, UL94V-0, Black
Terminal	Brass, Tin plated
Screw	Steel, M3, Nickel plated



Specifications

Working Temperature	-40°C ~ +130°C
Insulation withstand Voltage	AC2000V at 1 minute
Insulation Resistance	1000MΩ or more at DC500V
Wire range	22 ~ 14 AWG
Rated Torque Value	8 Kg - cm