

Barrier Style Terminal Blocks / DT-49

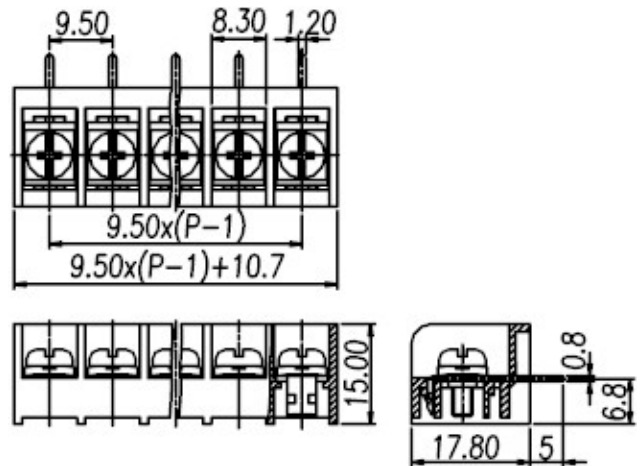

DT-49-B02X-XX



Pitch: 9.50mm

ORDER GUIDE

DT - 49 - [] 01 [] - [] []

- Pole size: 02~31P
- N : Round head screw
- W : Screw with washer
- A : Mount Ends
- B : Barrier Ends

Approval		FW2
Materials		
Rated voltage	300V	
Rated current	25A	
Plastic Housing	PA6.6, UL94V-0, Black	
Terminal	Brass, Tin plated	
Screw	Steel, # 6-32, Nickel plated	



Specifications

Working Temperature	-40°C ~ +105°C
Insulation withstand Voltage	AC2000V at 1 minute
Insulation Resistance	500MΩ or more at DC500V
Wire range	22 ~ 12 AWG
Rated Torque Value	13.8 Kg - cm

TEL: +886-2-2908-0614

FAX: +886-2-2908-8549

E-mail: infor@dinkle.com.tw