

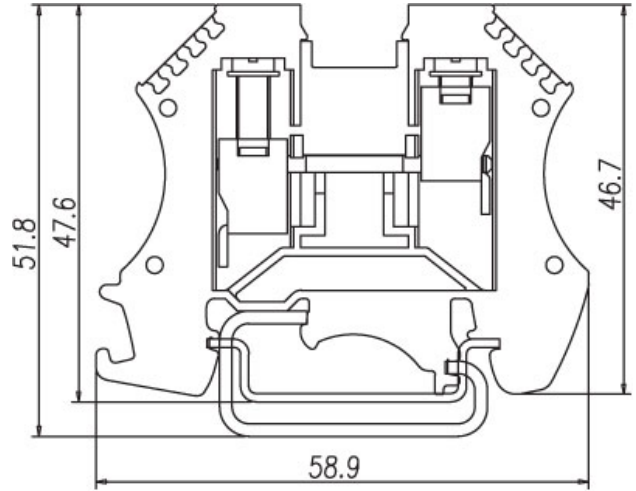

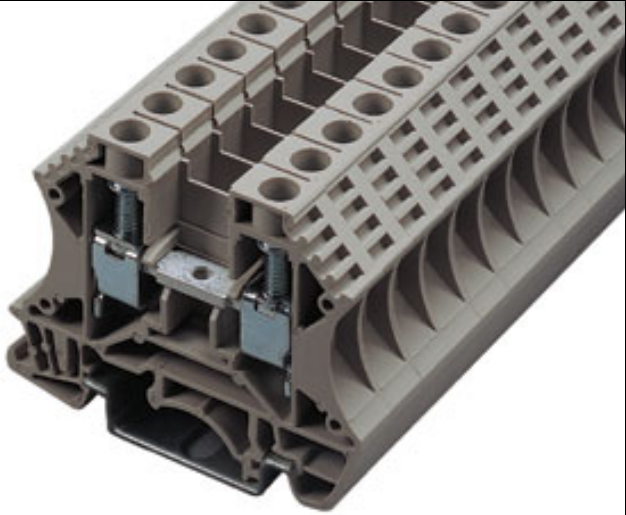

DIN Rail terminal blocks / DK series



DK6







TxHxW 8x47.6x58.9

Approval	  	
Technical Data	UL	IEC
Rated voltage	600V	500V
Rated current	45A	41A
Wire range		
Solid wire (AWG mm ²)	20~8	0.5~6
Stranded wire (AWG mm ²)	20~8	0.5~6
Rated surge voltage (UL/IEC/Max.)	2.2 / 2.5 / 8 KV	
Torque (Lb-in)	15.6	
Screw	M4	
Wire strip length	8mm	



Accessories	Cat. No.	
End cover	DK2.5C	
Partition	DKSPS-002	
Small partition	DKSPS-001	
Cross jumper - central type	DS6	02P
		03P
		10P
Cross jumper - cage inserting type	CSC-6	02P
		03P
		10P
Suitable plugs		
Marking label	TM28	
Suitable rail	TS-35	
	TS-32	
Tool	SDM4.0	

Optional color	Cat. No.
	DK6-RD
	DK6-BL
	DK6-BK
	DK6-OR