

EPK116VN-..P1

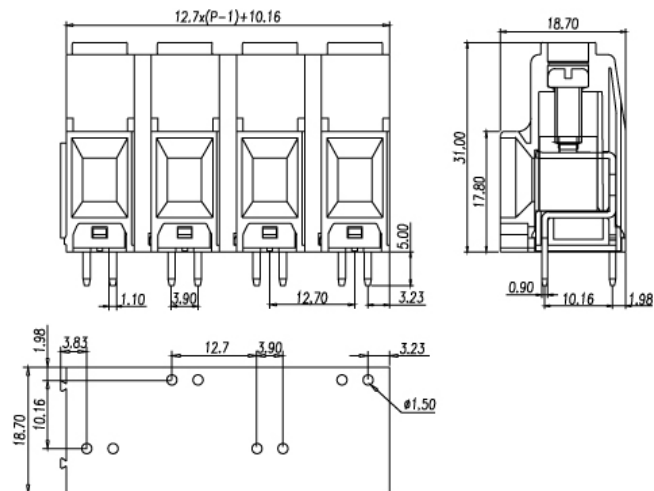

Pitch: 12.7mm

Approval		
Technical Data	UL	IEC
Rated voltage	600V	1000V
Rated current	57A	76A
Wire range		16mm ²
Solid wire (AWG)	20~6	
Stranded wire (AWG/mm ²)	20~6	
Rated surge voltage (UL/IEC/Max.)		
Torque (Lb-in)	10.5	
Screw	M4	
Wire strip length	12mm	
Pole	Cat. No.	
02	EPK116VN-02P1	
:	:	
:	:	
16	EPK116VN-16P1	