

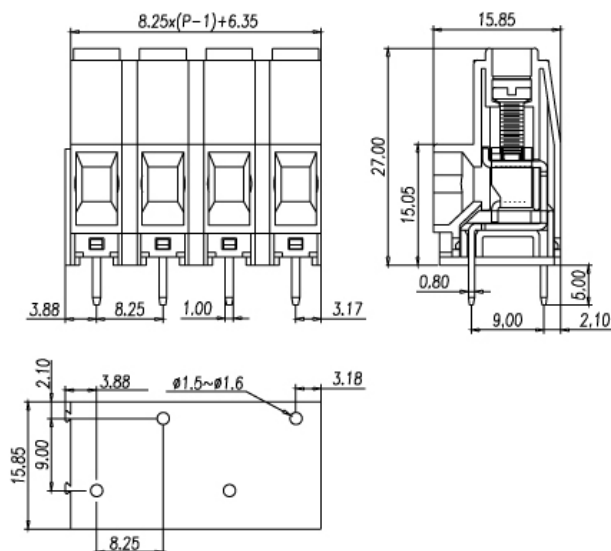

EPK635VN-..P1



Pitch: 8.25mm

Approval		
Technical Data	UL	IEC
Rated voltage	600V	800V
Rated current	35A	41A
Wire range		6mm ²
Solid wire (AWG)	18~8	
Stranded wire (AWG/mm ²)	18~8	
Rated surge voltage (UL/IEC/Max.)	2.2 / 3.5 / KV	
Torque (Lb-in)	4.4	
Screw	M3	
Wire strip length	7~8mm	
Pole	Cat. No.	
02	EPK635VN-02P1	
:	:	
:	:	
16	EPK635VN-16P1	